

SINGLE DC SOURCE CASCADED H-BRIDGE MULTILEVEL INVERTER USING THREE PHASE TRANSFORMERS FOR THREE PHASE APPLICATIONS

R.Venkatesh¹

¹(EEE Department, SNS College of Engineering, Coimbatore, India, rvenkatesh48@gmail.com)

Abstract—This paper proposes an H-Bridge Cascaded Three phase Multilevel Inverter. The proposed three phase Cascaded Multilevel Inverter makes use of single DC source. The proposed three phase Multilevel Inverter uses series connected three phase transformers so the number of single phase transformers used in traditional three phase Multilevel Inverter can be reduced. Hence the volume of the circuit is reduced, ease of control and flexibility of application. The switching losses and the harmonic components of the output voltage are reduced. The switching frequency of the proposed three phase Multilevel Inverter is equal to the fundamental frequency. Simulations are carried out to verify the performance of the proposed three phase Multilevel Inverter

Keywords—H-Bridge Cascaded three phase multilevel inverter; single DC source; series connected three phase transformer and harmonics

1. INTRODUCTION

The multilevel inverters use switching devices and capacitor voltage sources. By means of appropriate control of the switching devices, multilevel inverter generates the cascaded output voltages. The harmonic components of the output voltage are reduced. Multilevel inverters can overcome the disadvantages of traditional PWM inverters [1], [9]-[10]. Three types of multilevel inverters are present. They are diode-clamped multilevel inverter [3]-[4], flying capacitor multilevel inverter [3] and cascaded H-bridge multilevel inverter with separate dc sources [5]. The disadvantages of the diode-clamped multilevel inverter are that it requires more number of clamping diodes when the number of levels is high, difficult to control the real power flow of the individual converter in multilevel inverters and capacitor voltage unbalance problem [2]. The disadvantages of flying capacitor multilevel inverter are that it requires more number of capacitors when losses are high. The disadvantage of the traditional H-Bridge cascaded type multilevel inverter requires independent dc-link voltage source [2], [6]-[8], [11] - [12]. In this paper, the proposed H-Bridge Cascaded type multilevel inverter uses single DC source and series connected three phase transformers. By the proposed circuit configuration, number of single phase transformers can be reduced when compared with traditional three-phase multilevel inverters.

2. CIRCUIT DIAGRAM OF THE PROPOSED CASCADED H-BRIDGE THREE PHASE MULTILEVEL INVERTER

Fig.1. shows the circuit configuration of the proposed multilevel inverter for three-phase applications. The proposed multilevel inverter is designed to synthesize 7 output levels. It consists of single dc source and series connected three-phase transformers. To produce single phase “(2m+1)” output levels, “m” number of H-Bridges

has to be used. So to produce single phase 7 output levels, three H-Bridges has to be used. So to produce three phase 7 output levels, nine H- Bridges are used. The nine H-Bridges are R1,

Y1, B1, R2, Y2, B2, R3, Y3 and B3 as shown in the circuit diagram of fig.1.

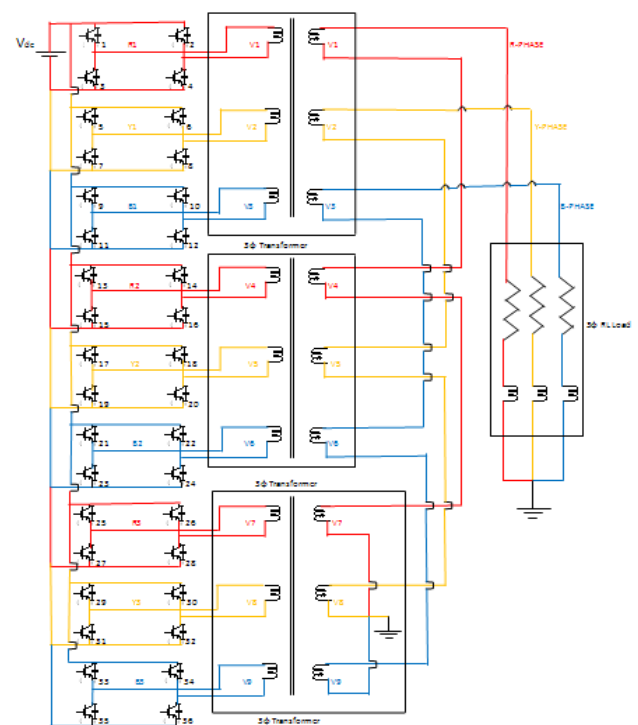

Fig.1. Circuit diagram of proposed H-Bridge cascaded three phase multilevel inverter.

In traditional multilevel inverters single phase transformers are used which increases the volume of the circuit and price of the system. In the proposed model, three phase transformers are used which reduces the volume of the

circuit and price of the system. Each primary terminal of the transformer is connected to an H-bridge module so as to synthesize V_{DC} , zero, and $-V_{DC}$. Every secondary of the transformer is connected in series to cascade the output voltage produced by inverter H-Bridges so as to obtain multilevel output voltage.

3. OPERATION OF THE CIRCUIT FOR R-PHASE

A. To produce positive half cycle of R-phase

H-Bridges R1, R2, R3 shown in the fig.1, produces the seven level output voltages of R-phase. Similarly H-Bridges Y1, Y2, Y3 and B1, B2, B3 produces the seven level output voltages of Y-phase and B-phase respectively. Operation of the circuit is discussed for R-phase. The seven level output voltage of R-phase is shown in fig.2

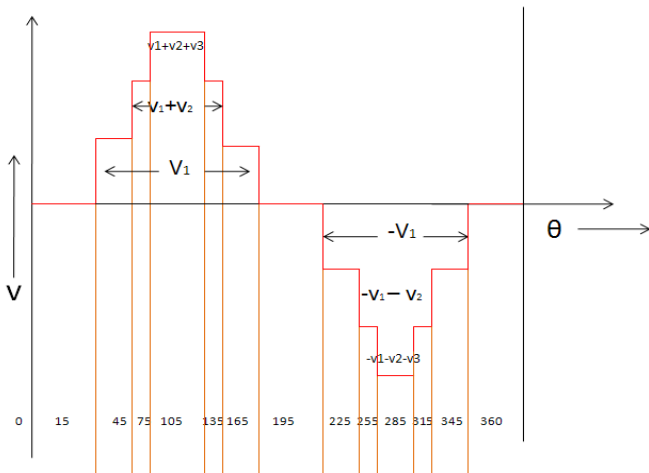

Fig.2. Seven level output voltage of R-phase

There are 5 modes of operation to produce positive half cycle of R-phase. The 5 modes of operation are tabulated in table 1.

TABLE I. MODES OF OPERATION TO PRODUCE POSITIVE HALF CYCLE OF R-PHASE

MODE	ANGLE	SWITCHES	OUTPUT VOLTAGE
1	0 to 15	NIL	0
2	15 to 165	1,4	V_1
3	45 to 135	13,16	V_1+V_4
4	75 to 105	25,28	$V_1+V_4+V_7$
5	165 to 180	NIL	0

1) *Mode 1*: No switches conduct from 0 to 15 degrees. The output voltage is 0.

2) *Mode 2*: Switches 1, 4 of H-Bridge R1 conduct from 15 to 165 degrees. The output voltage produced is V_1 .

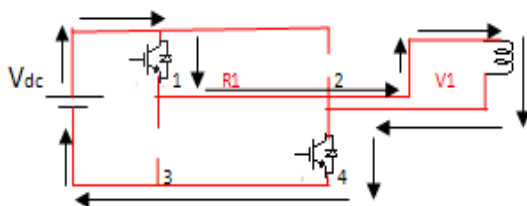

Fig.3.Circuit of Mode.2 operation

3) *Mode 3*: Switches 13, 16 of H-Bridge R2 conduct from 45 to 135 degrees. The output voltage produced is V_4 . The cascaded output voltage is V_1+V_4 .

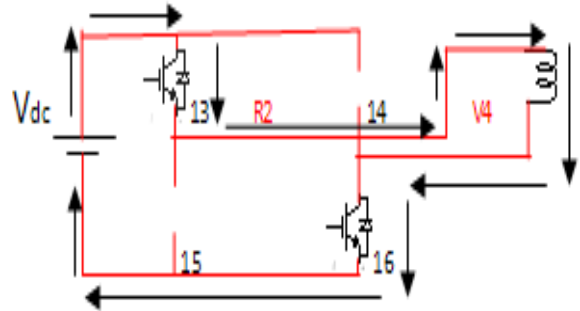

Fig.4.Circuit of Mode3 operation

4) *Mode 4*: Switches 25, 28 of H-Bridge R3 conduct from 75 to 105 degrees. The output voltage produced is V_7 . The cascaded output voltage is $V_1+V_4+V_7$.

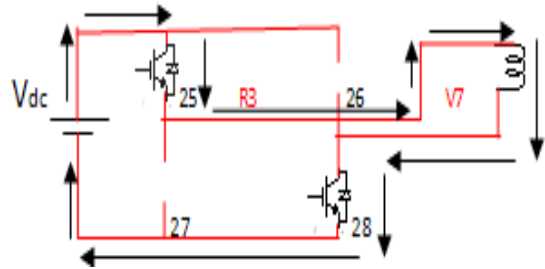

Fig.5.Circuit of Mode4 operation

5) *Mode 5*: No switches conduct from 165 to 180 degrees. The output voltage is 0.

Operation of Y-phase and B-phase is similar to R-phase with the phase shift of 120 degrees with each other.

4. SWITCHING PATTERN FOR GATE PULSES

Switches 1 & 4 of H-Bridge R1 is switched ON in mode 2. The gate pulses for switches 1 & 4 are given for the period from 15 to 165 degrees. The pulse width for switches 1 & 4 is calculated as,

$$\text{Pulse width} = \frac{\theta_2 - \theta_1}{360} \times 100\% \tag{1}$$

$$\text{Pulse width} = \frac{165 - 15}{360} \times 100\% \tag{2}$$

$$\text{Pulse width} = 40\% \tag{3}$$

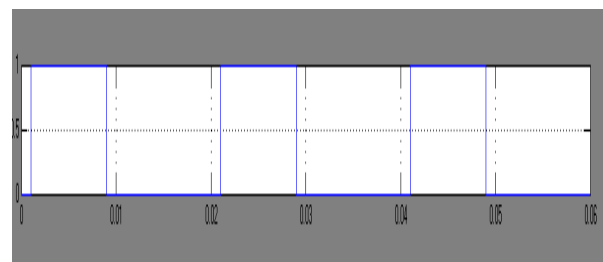

Fig.6. Gate pulses for switches 1 & 4.

5. CALCULATION OF OUTPUT PHASE VOLTAGES

$V_1, V_4,$ & V_7 are the output voltages of the H-bridge inverter R1,R2 and R3 respectively. $V_2, V_5,$ & V_8 are the output voltages of the H-bridge inverter Y1, Y2 and Y3 respectively. $V_3, V_6,$ & V_9 are the output voltages of the H-bridge inverter B1, B2 and B3 respectively. Cascaded output voltage is synthesized by the series connected secondary of the transformer outputs. Hence the output phase voltages are given by,

$$V_{RN} = V_1 + V_4 + V_7 \quad (4)$$

$$V_{YN} = V_2 + V_5 + V_8 \quad (5)$$

$$V_{BN} = V_3 + V_6 + V_9 \quad (6)$$

6. SIMULATION AND EXPERIMENTAL RESULTS

A. DC Input Voltage



Fig.7. DC Input voltage

B. R-Phase output Voltage with RL Load

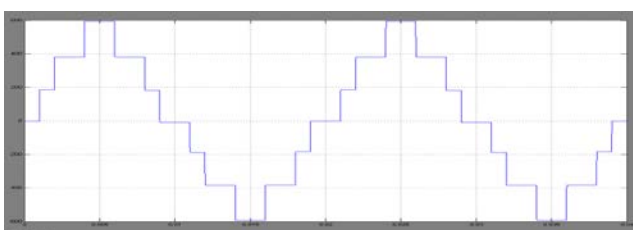

Fig.8.R-phase output voltage

C. Y-Phase output Voltage with RL load



Fig.9. Y-phase output voltage

D. B-Phase output voltage with RL load

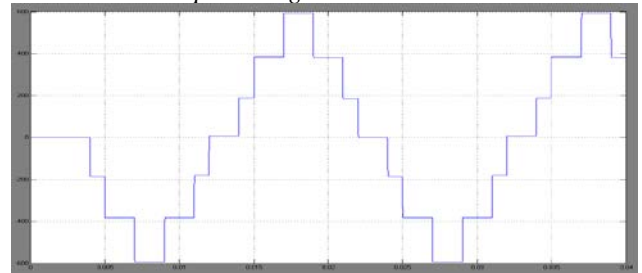

Fig.10. B-phase output voltage

Fig.8. to Fig.10 shows the simulation output waveforms for proposed seven level H-Bridge cascaded three phase multilevel inverter. When single DC source is applied, it has produced seven level three phase outputs such as +Vdc, +2Vdc, +3Vdc, 0, -Vdc, -2Vdc and -3Vdc. Single DC source of 200V is applied as input to the inverter. The seven level three phase outputs are produced as +200V, +400V, +600V, 0, -200V, -400V and -600V as shown in waveforms for three phase RL load.

7. CONCLUSION

This paper proposed an H-Bridge cascaded three phase multilevel inverter which uses three-phase transformers and single dc source. The proposed circuit configuration can reduce a number of transformers compared with conventional three-phase multilevel inverters using single-phase transformers. The proposed circuit configuration can also use a general switching method whose operating frequency is equal to that of the fundamental.

REFERENCES

- [1] F.S.Kang, S. J. Park, M. H. Lee, and C. U. Kim, "An efficient multilevel synthesis approach and its application to a 27-level inverter," IEEE Trans.Ind. Electron. vol. 52, no. 6, pp. 1600–1606, Dec. 2005.
- [2] M.H.Rashid, Power Electronics Handbook. New York: Academic, 2001, pp. 539-562.
- [3] D.Krug, S. Bernet, S. S. Fazel, K. Jalili, and M. Malinowski, "Comparison of 2.3-kV medium-voltage multilevel converters for industrial medium-voltage drives," IEEE Trans. Ind. Electron., vol. 54, no. 6, pp. 2979–2992, Dec. 2007.
- [4] A.Chen and X. He, "Research on hybrid-clamped multilevel-inverter topologies," IEEE Trans. Ind. Electron., vol. 53, no. 6, pp. 1898–1907, Dec. 2006.
- [5] Y.Cheng, C. Qian, M. L. Crow, S. Pekarek, and S. Atcity, "A comparison of diode-clamped and cascaded multilevel converters for a STATCOM with energy storage," IEEE Trans. Ind. Electron., vol. 53,no. 5, pp. 1512–1521, Oct. 2006.
- [6] F.S. Kang, S. J. Park, S. E. Cho, C. U. Kim, and T. Ise, "Multilevel PWM inverters suitable for the use of stand-alone photovoltaic power systems," IEEE Trans. Energy Convers., vol. 20, no. 4, pp. 906–915, Dec. 2005.
- [7] S.Kouro, J. Rebolledo, and J. Rodriguez, "Reduced switching-frequency modulation algorithm for high-power multilevel inverters," IEEE Trans.Ind. Electron. vol. 54, no. 5, pp. 2894–2901, Oct. 2007.
- [8] S.Khomfoi and L. M. Tolbert, "Fault diagnosis and reconfiguration for multilevel inverter drive using AI-based techniques," IEEE Trans. Ind. Electron., vol. 54, no. 6, pp. 2954–2968, Dec. 2007.

- [9] J. Rodriguez, S. Bernet, B. Wu, J. O. Pontt, and S. Kouro, "Multilevel voltage-source-converter topologies for industrial medium-voltage drives," *IEEE Trans. Ind. Electron.*, vol. 54, no. 6, pp. 2930–2945, Dec. 2007.
- [10] S. Daher, J. Schmid, and F. L. M. Antunes, "Multilevel inverter topologies for stand-alone PV systems," *IEEE Trans. Ind. Electron.*, vol. 55, no. 7, pp. 2703–2712, Jul. 2008.
- [11] J. S. Lai and F. Z. Peng, "Multilevel converters—A new breed of power converters," *IEEE Trans. Ind. Appl.*, vol. 32, no. 3, pp. 509–517, May/June 1996.
- [12] C. Newton and M. Sumner, "Multi-level converters a real solution to medium/high-voltage drives?" *Power Eng. J.*, pp. 21–26, Feb. 1998.